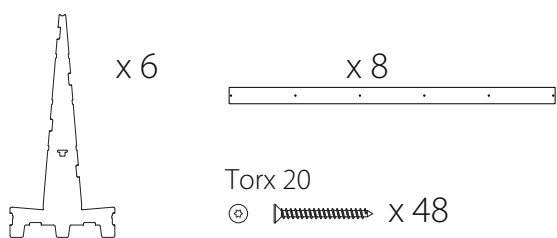
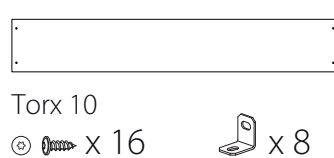



Table of contents:





TR80.150 / 5 uprights

 <p>x 5 x 8</p> <p>Torx 20 ⊕  x 40</p>	<p style="text-align: center;">Optional Baseboard kit</p>  <p>Torx 10 ⊕  x 16  x 8</p>
--	---

TR80.180 / 6 uprights

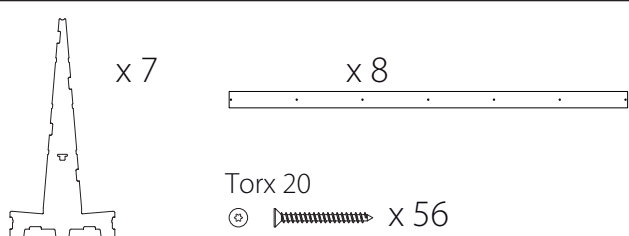
 <p>x 6 x 8</p> <p>Torx 20 ⊕  x 48</p>	<p style="text-align: center;">Optional Baseboard kit</p>  <p>Torx 10 ⊕  x 16  x 8</p>
--	---

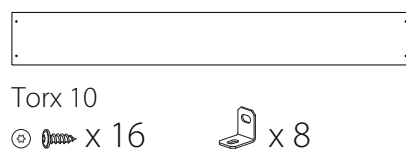
TR80.220 / 7 uprights

 <p>x 7 x 8</p> <p>Torx 20 ⊕  x 56</p>	<p style="text-align: center;">Optional Baseboard kit</p>  <p>Torx 10 ⊕  x 16  x 8</p>
---	---

Assembly instructions:

- No Baseboard: Step ① ⑤ ⑥ ⑦
- Baseboard: Step ① ③ ④ ⑤ ⑥ ⑦
- Optional MSC Safety clamp: Step ②

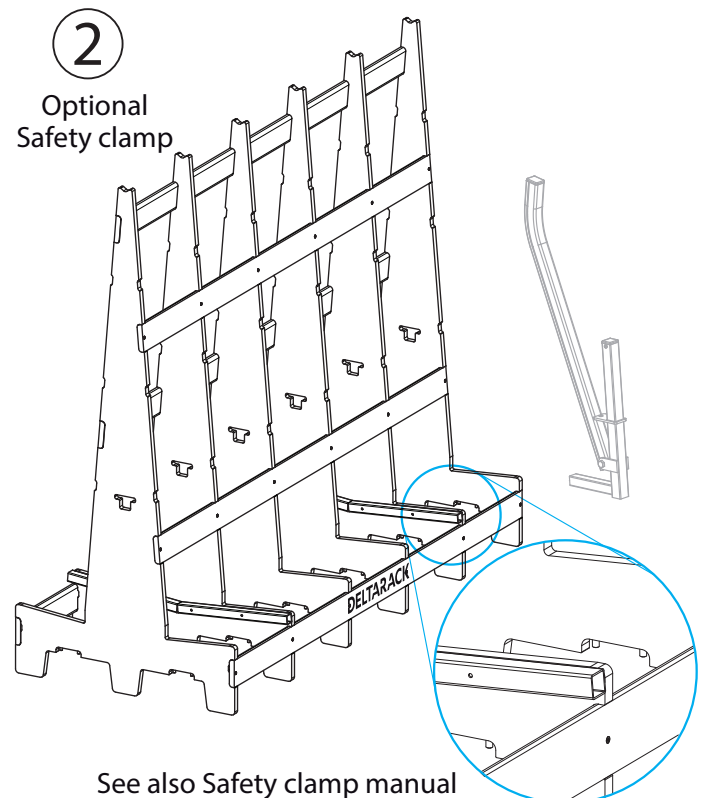
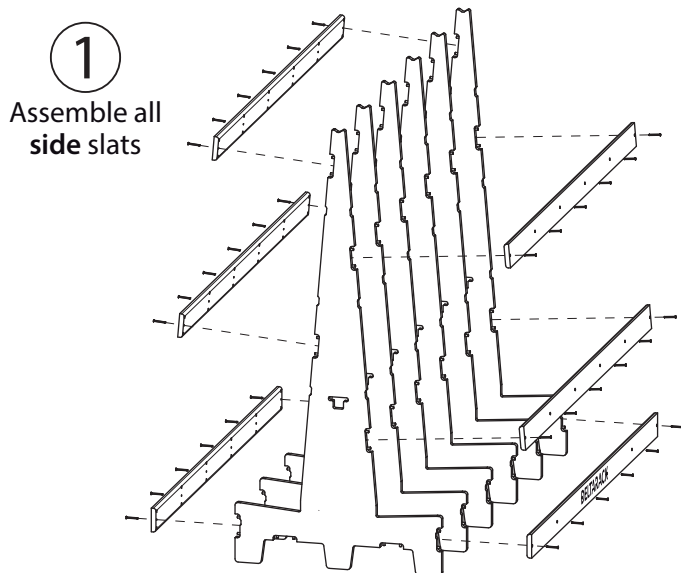

3

Assemble hooks
to the 2 Baseboards

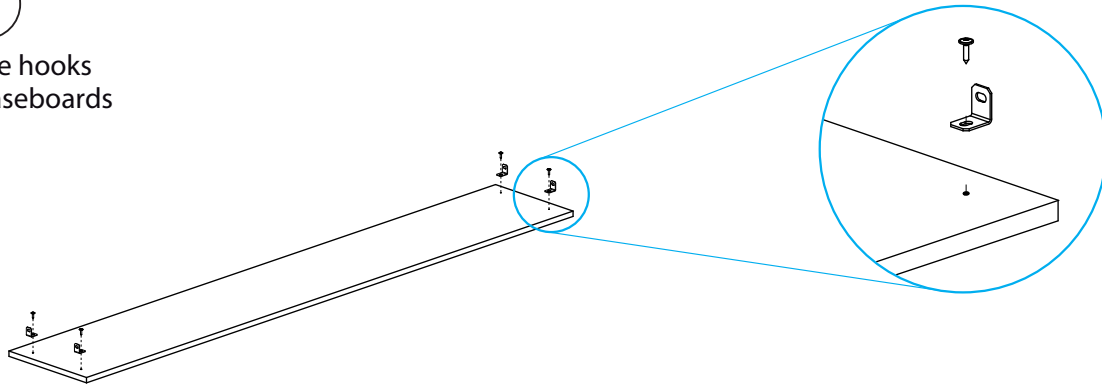

4

Assemble
the 2 Baseboards
to rack

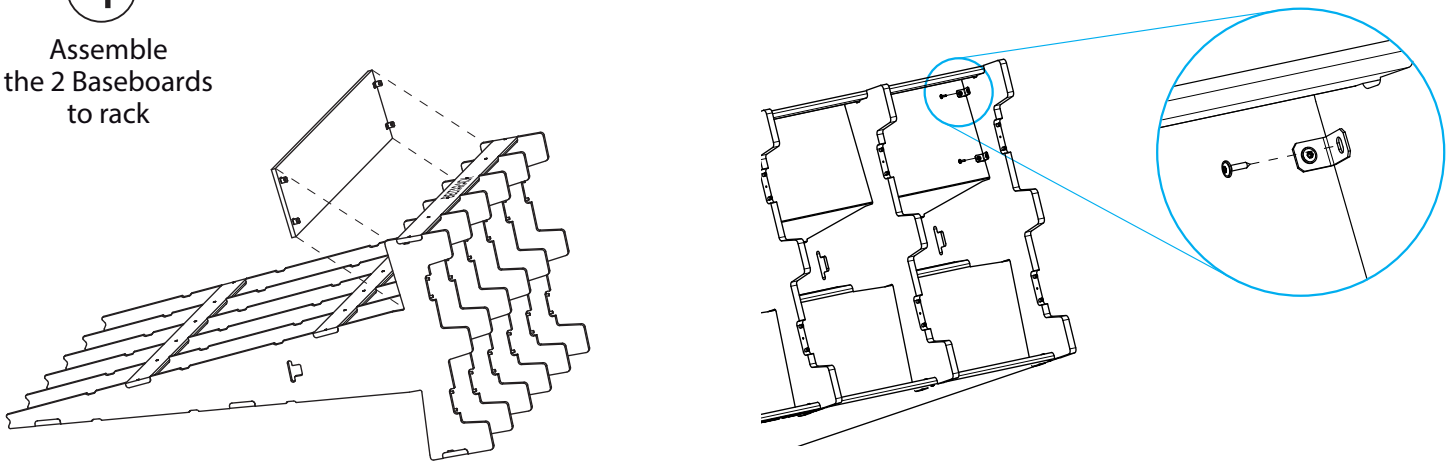

5

Add bottom
slats

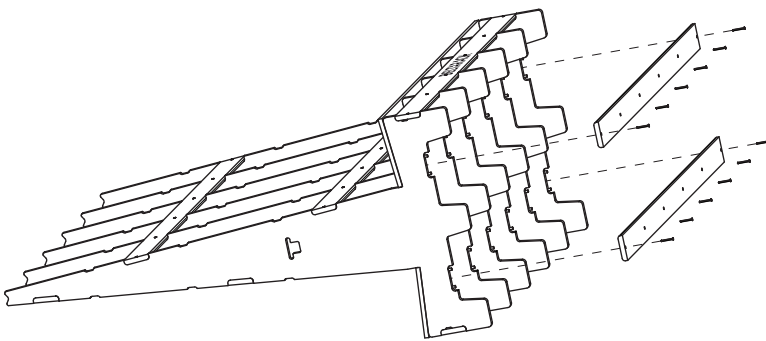

6

Base rack completed

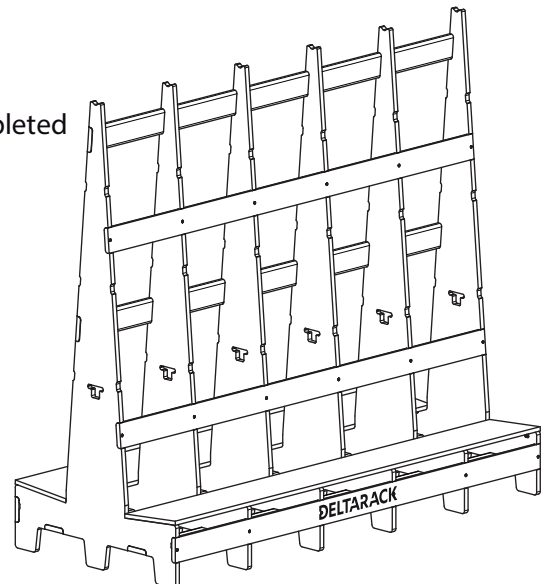

7

Build
wheelboards

See Wheelboard Assembly Guidelines